

TECHNICAL DATA : E-VER 12-600 C

Machine type		E-VER 12-600 C
LOAD HANDLING DATA		
Lifting capacity / Load centre distance	kg / mm	12 000 / 600
Maximum lifting speed, unloaded / at 70% of rated load	m/s	0,57 / 0,55
Maximum lowering speed, unloaded / at rated load	m/s	0,51 / 0,56
DRIVING DATA		
Drive speed forward, unloaded / at rated load	km/h	22 / 20
Drive speed reverse, unloaded / at rated load	km/h	22 / 20
Average energy consumption @ 8% energy recovery	kWh/h	15-22
Incline (driving ability) at rated load at 0-6 km/h / at 15 km/h	%	17 / 10
Towing (tractive ability) at rated load at 0-6 km/h / at 15 km/h	kN	47 / 28
SERVICE MASS / AXLE LOADS		
Service mass	kg	15 800
Axle load front, unloaded / at rated load	kg	8 200 / 25 900
Axle load rear, unloaded / at rated load	kg	7 600 / 1 900
TRACTION MOTOR		
Motor make		Kessler
Type / cooling		Direct drive Permanent magnet synchronous / water-glycol
Continuous power	kW	110
Continuous torque	Nm	310
LOAD HANDLING MOTOR		
Motor make		Parker
Type / cooling		Direct drive Permanent magnet synchronous / water-glycol
Continuous power	kW	77
DRIVE AXLE & BRAKING SYSTEM		
Drive axle make / model name		Kessler / D81
Drive axle type		Mechanical differential
Service brake system, type / affected wheels		Re-generative traction motor braking, Oil cooled Wet Disc Brakes / drive wheels
Parking brake system / type / affected wheels		Dry disc brake / spring release / drive wheels
STEER AXLE & STEER SYSTEM		
Steer axle make / type		Konecranes / double acting single cylinder
Parking brake, type / affected wheels		Hydraulic servo assisted, power steering
STEER AXLE & STEER SYSTEM		
Steer axle make / type		Konecranes / double acting single cylinder
Steering system		Hydraulic servo assisted / power steering
WHEELS		
Number of wheels, front+rear / Type (*driven)		4*+2 / pneumatic
Tyre pressure front / rear	MPa	1,0 / 1,0
Tyre dimensions (Ply rating) front / rear	Inch (No)	11.00 x 20" (PR 20) / 11.00 x 20" (PR 20)
Rim dimension front / rear	Inch	8.00 x 20" / 8.00 x 20"
HYDRAULIC SYSTEM		
Hydraulic pump make, model name		Parker P2-series
Hydraulic system / pump type		Load sensing system / variable axial piston pump
Power-on-demand / Low energy		Yes / yes
Hydraulic oil pressure mast	MPa	24
HIGH VOLTAGE BATTERY		
Type / cooling		Li-ion / water-glycol
Rated capacity	Ah	264 (2x132)
Rated energy	kWh	184 (2x92)
Nominal voltage	V	697
Mass	kg	1226 (2x613)
Cooling / Heating / active		Water-glycol
Charging connection		CCS2, DC fast charging
LIFTING EQUIPMENT		
Lift mast model / mast type / design		Konecranes duplex standard / 2-stage / free visibility
Carriage make / model		Konecranes / Hydraulic integral roller type
Fork make / Model		Konecranes / Roller type
OTHERS		
Noise level (inside Cab / Lm) DIN 45635	dB(A)	67
Noise level (inside Cab/ LpAZ) EN 12053 (EU + EFTA only)	dB(A)	73
Maximum noise level, outside LWA 2000/14/EC (EU + EFTA only)	dB(A)	104
NORMS & STANDARDS		
Stability of Industrial Trucks ISO 22915-2		Yes
Safety of Industrial Trucks EN ISO 3691-1 and ISO/TS 3691-7		Yes
Electrical/electronic requirements EN 1175:2020		Yes

TECHNICAL DATA : E-VER 12-600 C

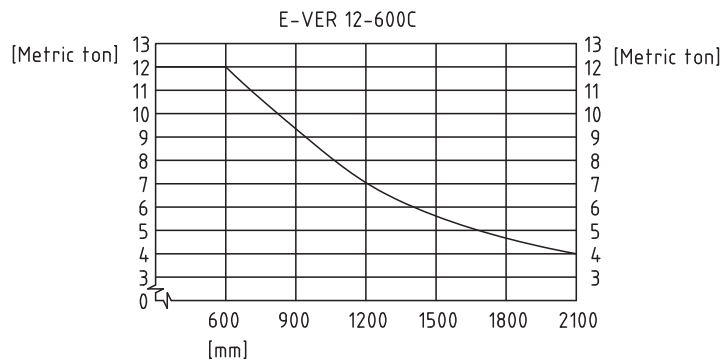
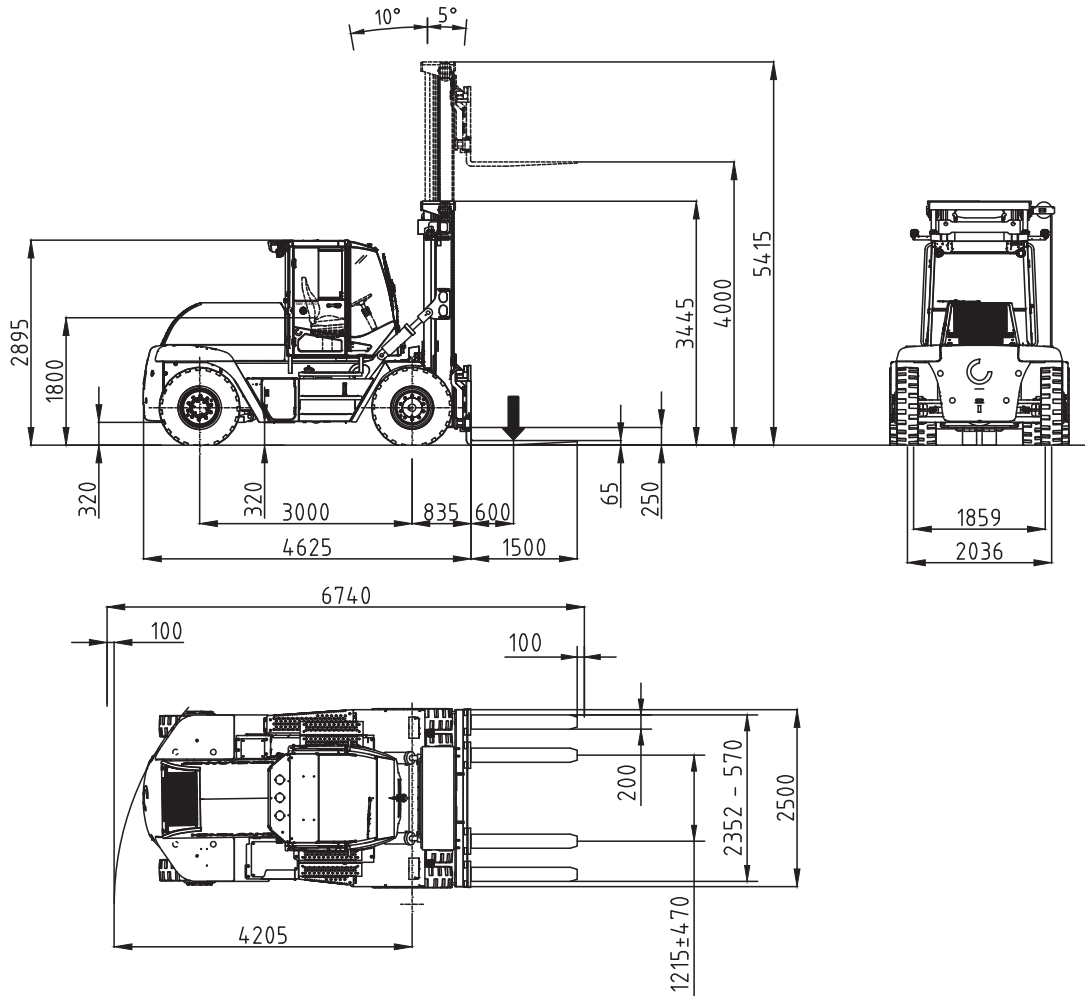

210331/1